







Chime Tone Intercom

DOOR 1 ROOM 1 IE-1AD(U)

Door station  IF-DA Door station → P.31	Master station  IE-1AD(U) Master station	Lineup  EL-12S Electric door strike → P.101  AC-10S Access control keypad, surface mount → P.99  IER-2 Call extension → P.101  AC-10F Access control keypad, flush mount → P.99  TAR-3 External signaling relay → P.32
Power supply 12~24V DC power supply 12~16V AC transformer		

Features

- Chime tone intercom for 2 locations
- Door release button
- AC or DC power source

Communication network

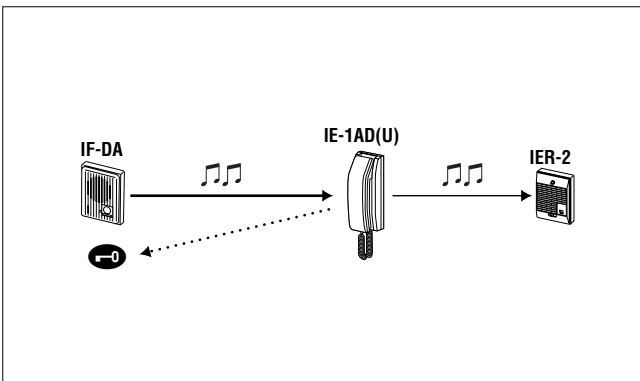

Unit dimensions

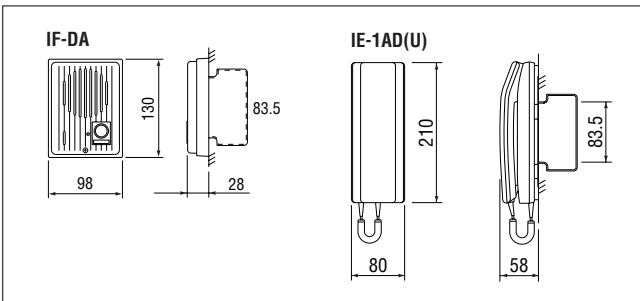

Wiring

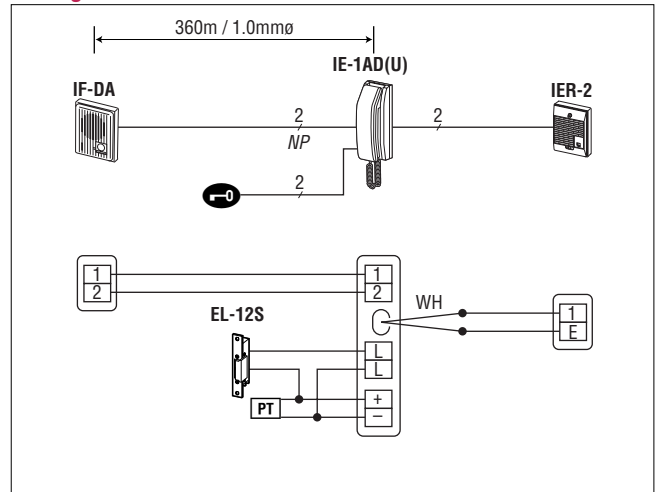

- Run audio wires in a separate jacketed cable from door release wires.
- [PT] : AC transformer WH : White(2)

Specifications (IE-1AD(U))

Power source	12~16V AC, 180mA 12~24V DC, 160mA
Power supply	AC transformer (for IE & EL-12S), PS-1225/S/UL.
Communication	Door calls in w/4-tone chime, adjustable. Pick up handset to reply.
Door release	Contact rating: 24V AC/DC, 500mA
Wiring	2 parallel wires, non-polarized (+2 for EL-12S)
Distance	IE-1AD(U) to door 150m(0.65mmø) 360m(1.0mmø)