







# Chime Tone Intercom

## DOOR 1 ROOM 1 IE-1AD(U)

<p><b>Door station</b></p>  <p><b>IF-DA</b> Door station → P.31</p>	<p><b>Master station</b></p>  <p><b>IE-1AD(U)</b> Master station</p>	<p><b>Lineup</b></p> <div style="display: flex; flex-wrap: wrap;"> <div style="width: 50%;">  <p><b>EL-12S</b> Electric door strike → P.101</p> </div> <div style="width: 50%;">  <p><b>AC-10S</b> Access control keypad, surface mount → P.99</p> </div> <div style="width: 50%;">  <p><b>IER-2</b> Call extension → P.101</p> </div> <div style="width: 50%;">  <p><b>AC-10F</b> Access control keypad, flush mount → P.99</p> </div> <div style="width: 50%;">  <p><b>TAR-3</b> External signaling relay → P.32</p> </div> </div>
<p><b>Power supply</b> 12~24V DC power supply 12~16V AC transformer</p>		

### Features

- Chime tone intercom for 2 locations
- Door release button
- AC or DC power source

### Communication network

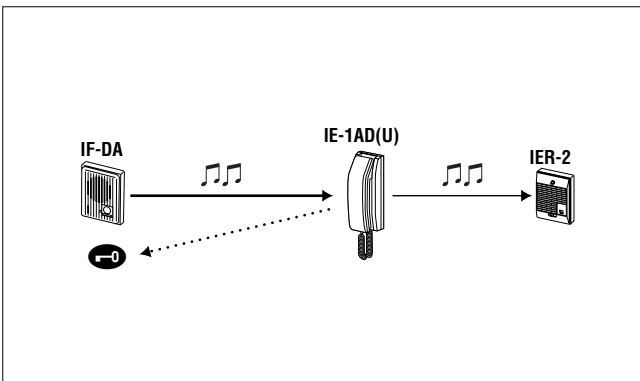

### Unit dimensions

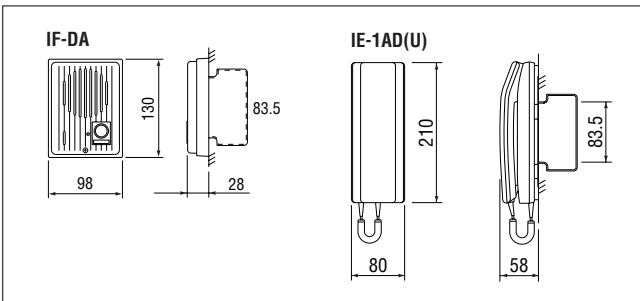

### Wiring

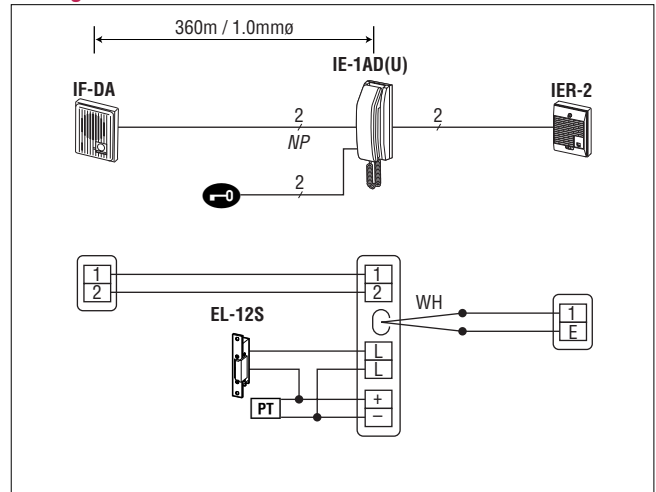

- Run audio wires in a separate jacketed cable from door release wires.
- [PT] : AC transformer WH : White(2)

### Specifications (IE-1AD(U))

Power source	12~16V AC, 180mA 12~24V DC, 160mA
Power supply	AC transformer (for IE & EL-12S), PS-1225/S/UL.
Communication	Door calls in w/4-tone chime, adjustable. Pick up handset to reply.
Door release	Contact rating: 24V AC/DC, 500mA
Wiring	2 parallel wires, non-polarized (+2 for EL-12S)
Distance	IE-1AD(U) to door 150m(0.65mmø) 360m(1.0mmø)